

# DUS60E-TJKFOACA

DUS60

INCREMENTAL ENCODERS

**SICK**  
Sensor Intelligence.

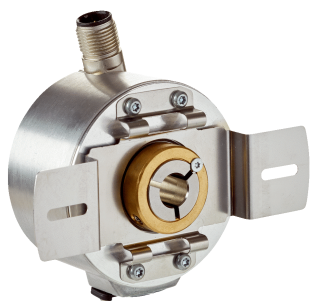

Illustration may differ



### Ordering information

Type	Part no.
DUS60E-TJKFOACA	1084480

Other models and accessories → [www.sick.com/DUS60](http://www.sick.com/DUS60)

### Detailed technical data

#### Performance

<b>Measuring step</b>	90° electric/pulses per revolution
<b>Measuring step deviation</b>	± 18° / pulses per revolution
<b>Error limits</b>	Measuring step deviation x 3
<b>Duty cycle</b>	≤ 0.5 ± 5 %

#### Interfaces

<b>Communication interface</b>	Incremental
<b>Communication Interface detail</b>	TTL / HTL <sup>1)</sup>
<b>Parameterising data</b>	DIP switch, selectable output
<b>Output function</b>	A and B output
<b>Initialization time</b>	< 5 ms <sup>2)</sup>
<b>Output frequency</b>	+ 60 kHz
<b>Load current</b>	≤ 30 mA, per channel
<b>Operating current</b>	≤ 120 mA (without load)
<b>Power consumption</b>	≤ 1.25 W (without load)
<b>4.5 V... 5.5 V, TTL/RS-422</b>	
Load current	≤ 30 mA, per channel
Operating current	≤ 120 mA (without load)
<b>TTL/RS-422</b>	
Load current	≤ 30 mA, per channel
Power consumption	≤ 1.25 W (without load)
<b>HTL/Push pull</b>	
Load current	≤ 30 mA, per channel
Power consumption	≤ 1.25 W (without load)
<b>TTL/HTL</b>	
Load current	≤ 30 mA, per channel

<sup>1)</sup> The output is not selectable for DIP switch configurations E, F, and G. The output voltage value is dependent on the supply voltage.

<sup>2)</sup> Valid positional data can be read once this time has elapsed.

Power consumption	≤ 1.25 W (without load)
<b>DIP switch parameters</b>	
Pulses per revolution	✓
Output voltage	✓
Direction of rotation	✓
<b>Configuration switches</b>	1800 PPR values, direction selection, TTL/HTL selectable

<sup>1)</sup> The output is not selectable for DIP switch configurations E, F, and G. The output voltage value is dependent on the supply voltage.

<sup>2)</sup> Valid positional data can be read once this time has elapsed.

## Electrical data

<b>Connection type</b>	Male connector, M12, 4-pin, universal <sup>1)</sup>
<b>Supply voltage</b>	4.75 ... 30 V
<b>Reference signal, number</b>	1
<b>Reference signal, position</b>	180°, electric, gated with A
<b>Reverse polarity protection</b>	✓
<b>Short-circuit protection of the outputs</b>	✓
<b>MTTF: mean time to dangerous failure</b>	275 years (EN ISO 13849-1) <sup>2)</sup>

<sup>1)</sup> The universal connection is rotatable so that it is possible to position the connector in the radial or axial direction.

<sup>2)</sup> This product is a standard product and does not constitute a safety component as defined in the Machinery Directive. Calculation based on nominal load of components, average ambient temperature 40 °C, frequency of use 8760 h/a. All electronic failures are considered hazardous. For more information, see document no. 8015532.

## Mechanical data

<b>Mechanical design</b>	Through hollow shaft, Front clamp
<b>Shaft diameter</b>	5/8"
<b>Flange type / stator coupling</b>	2-point stator coupling, slot, hole diameter 63 mm – 83 mm
<b>Weight</b>	0.25 kg <sup>1)</sup>
<b>Shaft material</b>	Stainless steel
<b>Flange material</b>	Aluminum
<b>Housing material</b>	Aluminum
<b>Material, cable</b>	PVC
<b>Start up torque</b>	0.5 Ncm (+20 °C)
<b>Operating torque</b>	0.4 Ncm (+20 °C)
<b>Permissible shaft movement, axial static/dynamic</b>	± 0.5 mm / ± 0.2 mm
<b>Permissible shaft movement, radial static/dynamic</b>	± 0.3 mm / ± 0.1 mm
<b>Operating speed</b>	1,500 min <sup>-1</sup>
<b>Moment of inertia of the rotor</b>	50 gcm <sup>2</sup>
<b>Bearing lifetime</b>	3.6 x 10 <sup>9</sup> revolutions
<b>Angular acceleration</b>	≤ 500,000 rad/s <sup>2</sup>

<sup>1)</sup> Relates to encoders with male connector outlet.

### Ambient data

<b>EMC</b>	According to EN 61000-6-2 and EN 61000-6-3
<b>Enclosure rating</b>	IP65 <sup>1)</sup>
<b>Permissible relative humidity</b>	90 % (condensation of the optical scanning not permitted)
<b>Operating temperature range</b>	-30 °C ... +90 °C
<b>Storage temperature range</b>	-40 °C ... +75 °C
<b>Resistance to shocks</b>	100 g (EN 60068-2-27)
<b>Resistance to vibration</b>	30 g, 10 Hz ... 2,000 Hz (EN 60068-2-6)

<sup>1)</sup> When the mating connector is installed and the DIP switch door is sealed with the encoder housing.

### Classifications

<b>ECl@ss 5.0</b>	27270501
<b>ECl@ss 5.1.4</b>	27270501
<b>ECl@ss 6.0</b>	27270590
<b>ECl@ss 6.2</b>	27270590
<b>ECl@ss 7.0</b>	27270501
<b>ECl@ss 8.0</b>	27270501
<b>ECl@ss 8.1</b>	27270501
<b>ECl@ss 9.0</b>	27270501
<b>ECl@ss 10.0</b>	27270501
<b>ECl@ss 11.0</b>	27270501
<b>ETIM 5.0</b>	EC001486
<b>ETIM 6.0</b>	EC001486
<b>ETIM 7.0</b>	EC001486
<b>UNSPSC 16.0901</b>	41112113

Dimensional drawing (Dimensions in mm (inch))

Through hollow shaft with front clamping

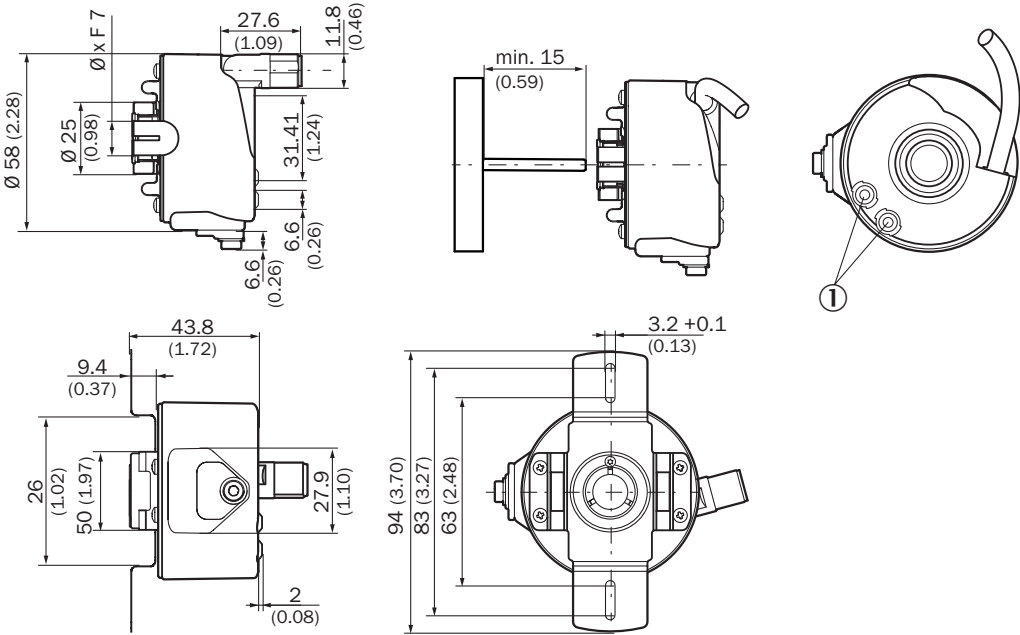

① Status indicators





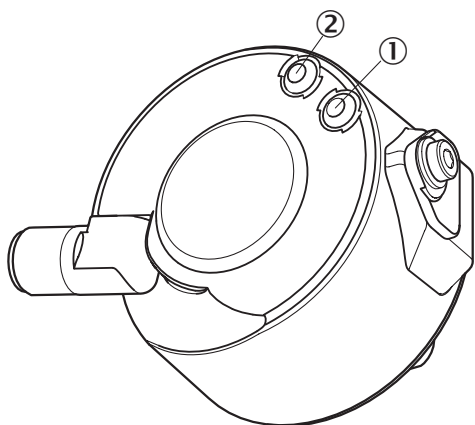



Type	Shaft diameter XF7
<b>Through hollow shaft with front clamping</b>	
DUS60x-TAxxxxxxx	6 mm
DUS60x-TBxxxxxxx	8 mm
DUS60x-TCxxxxxxx	3/8"
DUS60x-TDxxxxxxx	10 mm
DUS60x-TExxxxxxx	12 mm
DuS60x-TFxxxxxxx	1/2"
DUS60x-TGxxxxxxx	14 mm
DUS60x-THxxxxxxx	15 mm
DUS60x-TJxxxxxxx	5/8"



## Adjustments

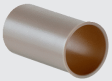

## Recommended accessories

Other models and accessories → [www.sick.com/DUS60](http://www.sick.com/DUS60)

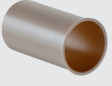
	Brief description	Type	Part no.
<b>Shaft adaptation</b>			
	Collet plastic insulated for hollow shaft, shaft diameter 6 mm, outer diameter 5/8" (15.875 mm), plastic	SPZ-58Z-006-P	2076228
	Collet metal for hollow shaft, shaft diameter 8 mm, outer diameter 5/8" (15.875 mm), metal	SPZ-58Z-008-M	2076219
	Collet plastic insulated for hollow shaft, shaft diameter 8 mm, outer diameter 5/8" (15.875 mm), plastic	SPZ-58Z-008-P	2076229
	Collet metal for hollow shaft, shaft diameter 10 mm, outer diameter 5/8" (15.875 mm), metal	SPZ-58Z-010-M	2076220
	Collet plastic insulated for hollow shaft, shaft diameter 10 mm, outer diameter 5/8" (15.875 mm), plastic	SPZ-58Z-010-P	2076230
	Collet metal for hollow shaft, shaft diameter 12 mm, outer diameter 5/8" (15.875 mm), metal	SPZ-58Z-012-M	2076221
	Collet plastic insulated for hollow shaft, shaft diameter 12 mm, outer diameter 5/8" (15.875 mm), plastic	SPZ-58Z-012-P	2076231
	Collet metal for hollow shaft, shaft diameter 14 mm, outer diameter 5/8" (15.875 mm), metal	SPZ-58Z-014-M	2076222
	Collet plastic insulated for hollow shaft, shaft diameter 14 mm, outer diameter 5/8" (15.875 mm), plastic	SPZ-58Z-014-P	2076232

	Brief description	Type	Part no.
	Collet metal for hollow shaft, shaft diameter 15 mm, outer diameter 5/8" (15.875 mm), metal	SPZ-58Z-015-M	2076223
	Collet plastic insulated for hollow shaft, shaft diameter 15 mm, outer diameter 5/8" (15.875 mm), plastic	SPZ-58Z-015-P	2076233
	Collet metal for hollow shaft, shaft diameter 1/2" (12.7 mm), outer diameter 5/8" (15.875 mm), metal	SPZ-58Z-12Z-M	2076225
	Collet plastic insulated for hollow shaft, shaft diameter 1/2" (12.7 mm), outer diameter 5/8" (15.875 mm), plastic	SPZ-58Z-12Z-P	2076227
	Collet metal for hollow shaft, shaft diameter 3/8" (9.525 mm), outer diameter 5/8" (15.875 mm), metal	SPZ-58Z-38Z-M	2076224
	Collet plastic insulated for hollow shaft, shaft diameter 3/8" (9.525 mm), outer diameter 5/8" (15.875 mm), plastic	SPZ-58Z-38Z-P	2076226

Plug connectors and cables

	Head A: female connector, M12, 4-pin, straight, A-coded Head B: Flying leads Cable: Sensor/actuator cable, PUR, halogen-free, shielded, 2 m	YF2A24-020UB4XLEAX	2105499
	Head A: female connector, M12, 4-pin, straight, A-coded Head B: Flying leads Cable: Sensor/actuator cable, PUR, halogen-free, shielded, 5 m	YF2A24-050UB4XLEAX	2095729
	Head A: female connector, M12, 4-pin, straight, A-coded Head B: Flying leads Cable: Sensor/actuator cable, PUR, halogen-free, shielded, 10 m	YF2A24-100UB4XLEAX	2095730
	Head A: female connector, M12, 4-pin, straight, A-coded Head B: Flying leads Cable: Sensor/actuator cable, PUR, halogen-free, shielded, 20 m	YF2A24-200UB4XLEAX	2105497
	Head A: female connector, M12, 5-pin, straight Cable: CANopen, DeviceNet™, shielded	DOS-1205-GA	6027534

## SICK AT A GLANCE

SICK is one of the leading manufacturers of intelligent sensors and sensor solutions for industrial applications. A unique range of products and services creates the perfect basis for controlling processes securely and efficiently, protecting individuals from accidents and preventing damage to the environment.

We have extensive experience in a wide range of industries and understand their processes and requirements. With intelligent sensors, we can deliver exactly what our customers need. In application centers in Europe, Asia and North America, system solutions are tested and optimized in accordance with customer specifications. All this makes us a reliable supplier and development partner.

Comprehensive services complete our offering: SICK LifeTime Services provide support throughout the machine life cycle and ensure safety and productivity.

For us, that is “Sensor Intelligence.”

## WORLDWIDE PRESENCE:

Contacts and other locations –[www.sick.com](http://www.sick.com)